



# Operating instructions

(Translation of the original operating instructions)

## CartMaster wall 1 - IFA

## CartMaster wall 2 - IFA

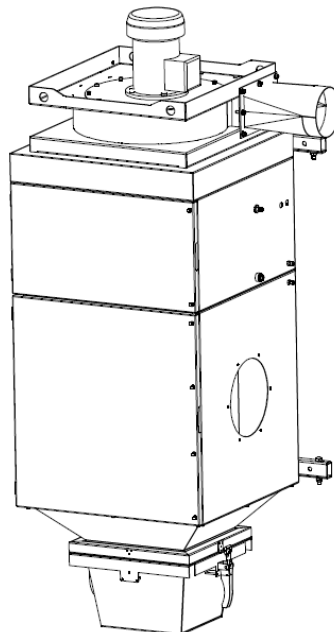

## Table of contents

<b>1. General</b>	<b>3</b>
<b>2. Description of the system elements</b>	<b>4</b>
2.1. Illustration of the system elements	4
2.2. Functionality of the system	5
2.3. Intended use	5
2.4. Residual risk	5
<b>3. Safety instructions</b>	<b>6</b>
3.1. Definition of the hazard symbols	6
3.2. General safety instructions	6
<b>4. Storage, transport and installation of the device</b>	<b>7</b>
4.1. Mounting of the unit to the wall	7
<b>5. Commissioning</b>	<b>9</b>
5.1. Connecting the suction line and exhaust air line	10
5.2. Electrical connection	11
5.3. Coating of the filter cartridges with cartridge protection	12
5.4. Connecting the compressed air supply	12
5.4.1. Compressed air supply for the cleaning of the filter cartridges	12
<b>6. Operating the system</b>	<b>13</b>
6.1. Explanation of the operating elements	13
<b>7. Maintenance</b>	<b>14</b>
7.1. Reset to maintenance state	15
7.2. Cleaning the filter cartridges	15
7.3. Replacing the filter cartridges	16
7.4. Emptying the dust collecting tank	21
7.5. Draining the condensate	22
7.6. Coating of new filter cartridges with cartridge protection	23
7.7. Cleaning the copper baffle plate	24
<b>8. Dismantling / Disposal</b>	<b>25</b>
<b>9. Diagnostics and troubleshooting</b>	<b>25</b>
<b>10. List of spare parts</b>	<b>27</b>
<b>11. Technical data</b>	<b>28</b>
<b>12. EC declaration of conformity</b>	<b>29</b>
<b>13. Training protocol</b>	<b>30</b>
<b>14. Maintenance intervals</b>	<b>31</b>
14.1. Usage-related maintenance	31
14.2. General maintenance	31
14.2.1. Visual inspection of the device	32
14.2.2. Visual inspection of the pipelines for dust deposits	32
14.2.3. Visual inspection of the pneumatic pipes	32
14.2.4. Functional test of the device	33

## 1. General

Congratulations on purchasing the product from TEKA.

Our engineers ensure that our devices reflect the state of the art through continuous development. Nevertheless, misuse or misconduct can endanger your safety. Please observe the following for a successful use of the device:

	<p>Only authorised and instructed personnel can carry out transport, operation, maintenance and repair of the device. The operator must ensure that the operating personnel take note of these instructions.</p> <p>Please read these instructions before operating the device, and observe the safety precautions to avoid injury!</p> <p>Store this manual in a safe place! These instructions are to be regarded as a component of the product!</p> <p>Adhere to all product notes!</p> <p>Modifications or conversions that the operator carries out at the device without the consent of the manufacturer, can lead to new safety hazards or to the loss of warranty claims.</p> <p>Observe the manufacturer's instructions. Contact the manufacturer in case of any uncertainty: Tel: +49 2541-84841-0 E-mail: <a href="mailto:info@teka.eu">info@teka.eu</a></p>
---	---

## 2. Description of the system elements

### 2.1. Illustration of the system elements

Installation example:

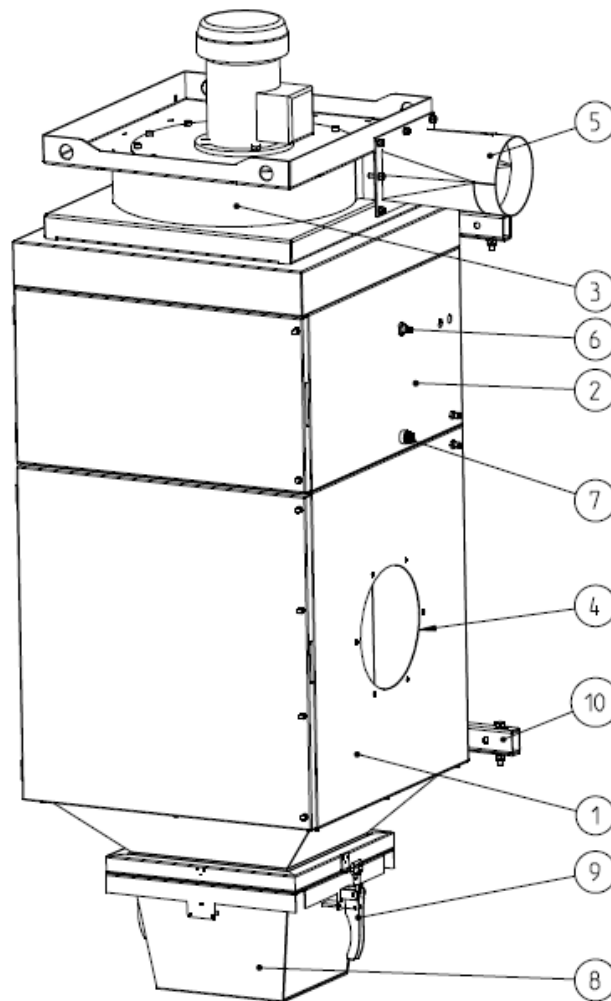

Z.Nr. 12471707

Pos.1	Filter housing	Pos.6	Connection for compressed air
Pos.2	Cleaning housing	Pos.7	Drain valve for compressed air
Pos.3	Fan	Pos.8	Dust collecting tank
Pos.4	Suction nozzle	Pos.9	Toggle lever
Pos.5	Exhaust air nozzle	Pos.10	Wall console

## 2.2. Functionality of the system

The filter unit serves to suck off and filter polluted air (according to the intended use). The air is purified on the surface of the filter cartridge in the filter section of the unit. The separated dust is collected in a dust collecting tank. An automatic filter monitoring indicates when a cleaning or a replacement of the filters is necessary. The purified air is led outside via the exhaust air pipe or back into the working room.

## 2.3. Intended use

The device is intended for commercial use. If the device is made publicly accessible, it must never be operated unsupervised by authorized personnel, authorized by the operator.

The filter unit is intended for extraction and filtration of dusts and fumes that result from thermal joining and cutting of metals. The filter unit is amongst others suitable for separating welding smokes of unalloyed and alloyed steels as well as of high-alloy chromium-nickel steels and therefore meets the highest welding fume separation category "W3" according to DIN EN ISO 21904-1 / -2.

	<b>WARNING</b>
	<p><b>Improper use can damage parts and be a danger to life and limb!</b> The device must not be used for the extraction of oil-laden welding fume, explosive dust and gases, hybrid mixtures, glowing or burning substances, gases, water, etc. The device must not be operated in explosive zones.</p> <hr/> <p><b>Dangers arising from fire.</b> If the sucked medium is combustible fume or dust, the operator must determine beforehand which fire protection measures are to be taken.</p>

## 2.4. Residual risk

	<b>CAUTION</b>
	<p><b>Danger due to possible hazardous materials in the exhaust air flow.</b> Because the unit does not monitor the quality of the air in the exhaust air flow, we recommend that you always guide the exhaust air flow exiting our unit to areas (e.g. to the outside into the open air) in which there is no danger to any living being. To do this, it is necessary to fit a suitable exhaust air line at the filter unit.</p>

### 3. Safety instructions

#### 3.1. Definition of the hazard symbols

The device is constructed according to the state of the art and the recognised safety regulations. Nevertheless, during use threats to life and limb of the user or other persons may arise. The impairment of the machine or other property are also possible. In these instructions we warn by using corresponding indications.

	<b>WARNING</b> <b>WARNING</b> These instructions are made in case of risks that can lead to <u>injury or death</u> .
---	--

	<b>CAUTION</b> <b>CAUTION</b> These instructions are made in case of risks that can lead to <u>injury</u> .
---	---

	<b>NOTICE</b> <b>NOTICE</b> These instructions are made in case of risks that can lead to <u>material damages</u> .
--	---

	Information notes are no hazard warnings; they call attention to useful information.
---	--

#### 3.2. General safety instructions

	<b>WARNING</b> <b>Dangers arising from improper use / unauthorised operations.</b> The operator must ensure that their authorised personnel are familiar with all the safety indications in this manual in advance. The operator is responsible for ensuring that all work is carried out by authorised and qualified personnel. We therefore recommend using the training protocol on the last page for that purpose (see chapter "Training protocol"). Laymen are allowed to operate the device after having received the necessary instructions. But they are not allowed to carry out any installation, repair or maintenance work.  <b>Dangers arising from fire.</b> In case of fire, if possible, switch the unit immediately off or disconnect it from the power supply. Fire extinguishing measures which the operator is obliged to determine beforehand must be initiated immediately.
---	--

	<b>WARNING</b>
	<p><b>Dangers arising from electricity.</b> The operator must ensure that electrical plants and equipment are only built, modified and maintained by a qualified electrician or under the direction and supervision of a qualified electrician. Do not work on components if you are not sure that these are disconnected. If necessary, disconnect the device from the electric power supply and secure it against unauthorized restarting.</p>

#### 4. Storage, transport and installation of the device

	<b>WARNING</b>
	<p><b>Risk of injury from tilting or unmounted components when stored or transported.</b> The device must be secured against tilting and slipping when it is stored or transported. Do not stand under or next to the floating load. Lift trucks, forklift trucks and transport cranes must have a sufficient minimum load bearing capacity.</p> <hr/> <p><b>Risk of injury arising from the falling unit at its destination.</b> The unit must be firmly mounted to the destined wall. The wall must be vibration-free and vertical. The operator must check if the wall provides a sufficient bearing capacity.</p>

	<b>NOTICE</b>
	<p><b>Damage or functional impairment of the unit due to climatic influences.</b> The unit must be stored in a dry place and protected against moisture during transport. As a matter of principle, the filter unit is not designed to be installed outdoors. In this case contact the manufacturer in order to find out if a capping or a trace heating system are necessary.</p>

#### 4.1. Mounting of the unit to the wall

Wall brackets are already attached to the filter unit upon delivery.

- The two other wall brackets must be screwed to the wall. Pay attention to an identical distance "X".

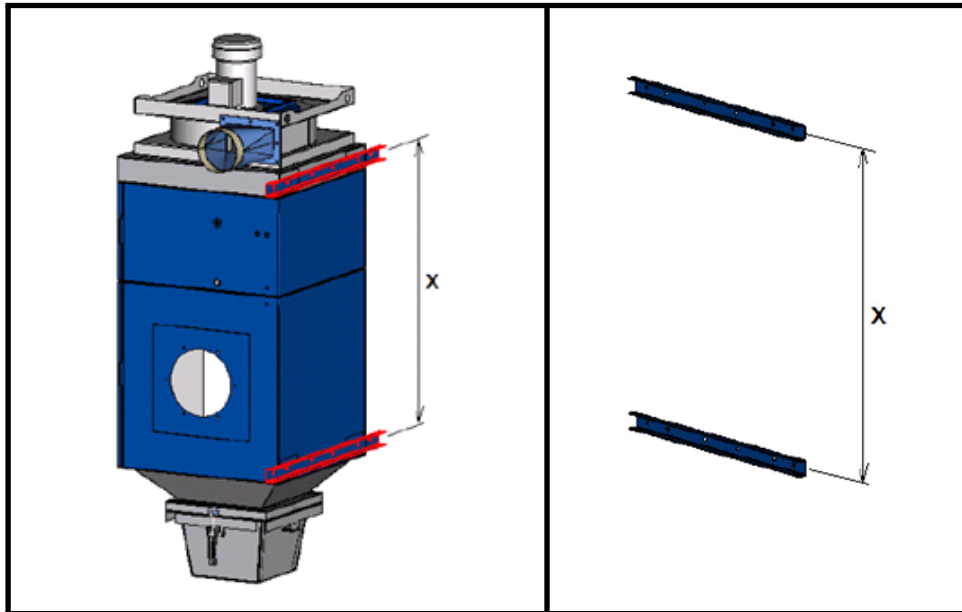

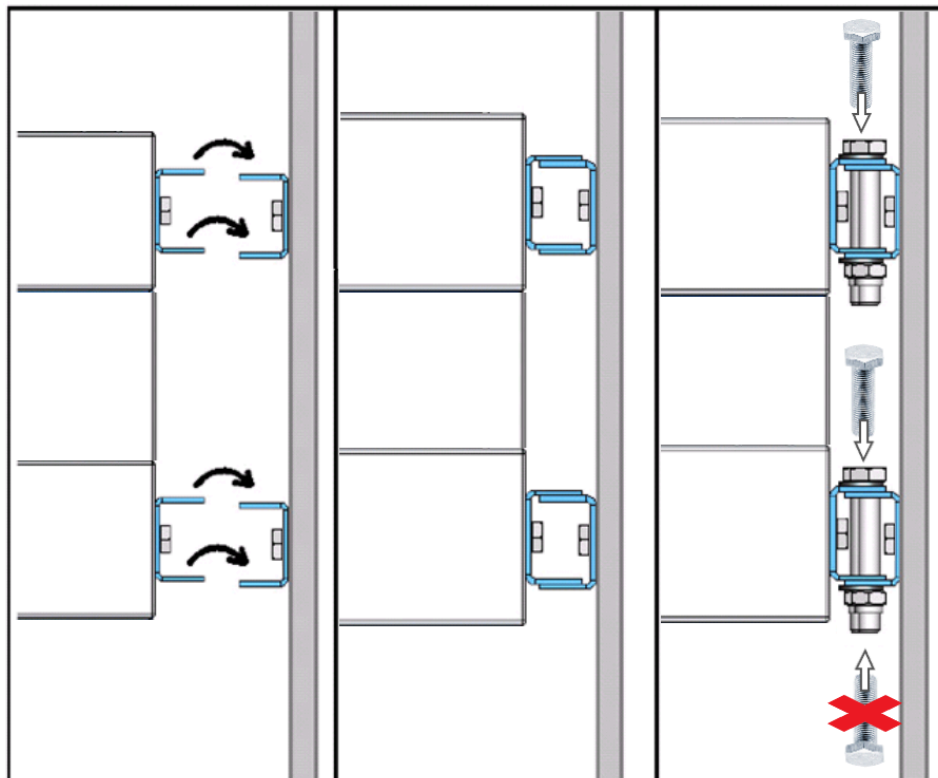

- Put the filter unit with its wall brackets on the wall brackets attached to the wall and screw them by means of the delivered screws.





## 5. Commissioning

	<b>WARNING</b>
<p><b>Dangers arising from a defective condition of the unit.</b> Make sure that the measures described in this chapter are completed before the commissioning of the unit. All doors of the unit must be closed and all necessary connections must be attached before turning the unit on. Do not operate the unit if any components are defective, missing or damaged. Check the orderly condition of the unit before switching it on. The unit must not be operated without a filter element.</p>	

	<b>NOTICE</b>
<p><b>Damaged supply lines.</b> Make sure that the supply lines are protected against damage by forklift trucks and similar events. Protect all supply lines from heat, moisture, oil and sharp edges.</p>	

## 5.1. Connecting the suction line and exhaust air line

For extracting the contaminated air, a suction line must be connected to the suction nozzle (see chapter 2.1).

	<b>CAUTION</b>
<p><b>Danger for the respiratory tract arising from polluted ambient air. Dust deposits in the suction pipe are possible.</b></p> <p>Only operate the system if the necessary suction line is fitted. The suction line must be dimensioned according to the application in such a way that, if possible, no dust deposits occur in the suction line. If this has not already been carried out by TEKA, a suitably qualified employee must be consulted. If the suction line includes extraction elements (e.g. suction arms, pipe grills, etc.), these must also be included in the layout. If this is the case then users must be informed of whether extraction elements can be used simultaneously and, if this is possible, then which. The regulating devices (e.g. throttle valves) of each single extraction element must also be set appropriately during the final commissioning.</p>	

Depending on the application, the suction pipe must be equipped with extraction elements (suction arm, extraction hose, round duct grille, etc.). When using a capture element with an extractor cowl, the extractor cowl must follow the weld seam, if possible by using the movement of the welding fume caused by thermal influences.

**CAUTION** : You have to make sure that connections between the workpiece and the suction hood (and in general between the workpiece and the filter unit) are avoided in order to prevent the welding current from flowing back to the welding machine via the protective conductor of the filter unit.

The exhaust air pipe must be attached to the exhaust nozzle (see chapter 2.1).

	<b>WARNING</b>
<p><b>Danger to life when reaching the fan impeller.</b></p> <p>The required exhaust air pipe must be attached before the commissioning.</p>	

	<p>The assembly of a suction arm is described in the separate operating manual.</p>
---	---

## 5.2. Electrical connection

	<b>WARNING</b>
	<p><b>Risk of electric shock.</b> Electrical plants and equipment may only be built, modified and maintained by a qualified electrician or under the direction and supervision of a qualified electrician. Do not work on live electrical components and elements if you are not sure that these are indeed disconnected. If necessary, disconnect the device from the mains. The operator is responsible for a potential-free balance of the equipment. If the unit is equipped with a frequency converter, then it may only be operated on networks with an AC/DC sensitive RCCB. The AC/DC sensitive residual current circuit breaker (type B) must tolerate at least a permissible residual current of 100mA. For frequency converter operation, the cross section of the protective conductor</p> <ul style="list-style-type: none"><li>• must be at least 10mm<sup>2</sup>,</li><li>• and must be at least equal to the size of the operator side outer conductor cross-section.</li></ul>

	<b>CAUTION</b>
	<p><b>Health hazard arising from unintentional cleaning processes.</b> Switch on the control only if the unit is in operational condition.</p>

	<b>NOTICE</b>
	<p><b>Electric malfunction possible in cause of an incorrect power supply.</b> Pay attention to the admissible supply voltage. Please observe the specifications on the type plate.</p>

- Mount the housing of the external control (if it is not mounted on the device itself) close to the device on the wall or at any other appropriate mounting point. Or mount the control together with a cabinet console on a suitable surface, for example using lag bolts or heavy-duty anchors.

**⚠WARNING** The housing is not suited for outdoor installation.

- Connect all visible cables and hoses according to their functions. When delivered they are labelled according to their functions. When connecting to the control, please observe the specifications on the circuit diagram which is attached to the control.
- Connect the unit to the power supply.
- Check if the direction of fan rotation is correct. A wrong rotation direction can be identified thanks to the sticker stuck to the fan scroll which is showing the direction. Compare the rotation direction on the sticker to the rotation direction of the motor cooling fan when the motor is running down after being switched off. If the motor rotates in the wrong direction, disconnect the device from the power supply and exchange two phases at the supply line to the control.



**⚠CAUTION** When the fan rotates in the wrong direction, the extraction capacity is reduced.

### 5.3. Coating of the filter cartridges with cartridge protection

For a longer service life of the filter cartridges we recommend to coat them with a cartridge protection. The coating can only be carried out during the commissioning at the operation site. When the operator orders and installs new filter cartridges, we recommend to also coat them before the commissioning.

**i** Please read and refer to "Coating of new filter cartridges with cartridge protection" in the chapter "Maintenance". There you can also find a description of the operating method of the cartridge protection.

### 5.4. Connecting the compressed air supply

**NOTICE**

**The compressed air must be dry and oil-free.**  
According to ISO 8573-1:2010 the compressed air quality must at least meet: [7:4:4]

- Partikle size: <math><40\mu\text{m}</math>
- Pressure dew point: <math>\leq +3^\circ\text{C}</math>
- Oil content: <math>\leq 5\text{mg}/\text{m}^3</math>

#### 5.4.1. Compressed air supply for the cleaning of the filter cartridges

The filter cartridges of the system are automatically cleaned. Cleaning is carried out pneumatically via a built-in compressed air tank.

**i** Without compressed air supply the filter cartridges will become dirty very quickly.

- The external compressed air supply must be assured with an approved compressed air hose. For the connection to the device, the compressed air hose must be equipped with a quick coupling for an insert sleeve DN 7.2.

**NOTICE** The compressed air must be dry and oil-free.

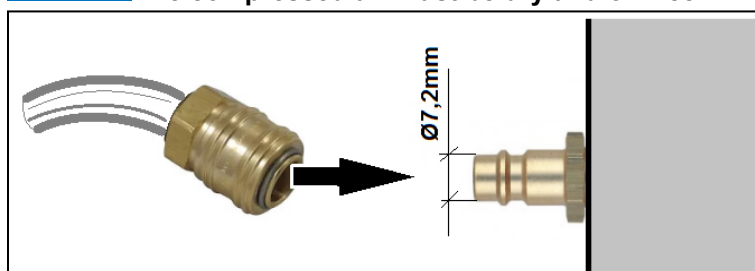

- The operating pressure of the compressed air supply must be a minimum of 3 bars and maximum of 4 bars.



**NOTICE** In case of the pressure being too low, the compressed air tank does not reach quickly enough the operating pressure for the following cleaning. There is a risk of material damage when the pressure is too high.

- Connect the compressed air hose to the insert sleeve (see chapter 2.1).

## 6. Operating the system

### 6.1. Explanation of the operating elements

 Control functions, setting options for programs, menu navigation, error messages, etc. are described in the enclosed operating manual of the unit control. There is also an explanation of the elements of the control panel.

Operating elements for the device control		
Representation	Designation	Description / function
	Main switch	<ul style="list-style-type: none"> <li>• <b>OFF:</b> The device is disconnected from the power supply.</li> <li>• <b>ON:</b> The device is connected to the power supply and ready to operate.</li> </ul> <p> The main switch also serves as an emergency off switch.</p>

Operating elements for status and error messages		
Representation	Designation	Description / function
	Stroboscope flash	The stroboscope flash draws attention to an error message of the device control by flashing up. The error message is shown on the display of the control.

## 7. Maintenance

In accordance with national regulations, the operator is obliged to carry out repeat and functional tests. Unless otherwise specified by national regulations, we recommend regular visual inspections and functional tests of the device as described in the chapter "Maintenance intervals".



You find the chapter "Maintenance intervals" at the end of the document. The general maintenance (visual inspection, etc.) is also explained there.

In the chapter "Maintenance intervals" there is information on the maintenance intervals of the filter elements. But these are only recommendations. Depending on the application (multi-shift operation, dust generation, ...) it may be necessary for the operator to change the maintenance intervals.

In this chapter the maintenance work which is caused by wear caused during operation is described.



### WARNING

**Work on the open system entails the risk of electrical shock or accidental restart the system. Both pose a danger to life and limb.**

When cleaning and servicing equipment during the replacement of parts or when changing to another function, set the device to maintenance condition first (see chapter "Reset to maintenance state").

A recommissioning of the device must only occur if it is ensured that the device is functionally equivalent to the original state.



### CAUTION

**Hazards to the respiratory tracts are possible.**

All maintenance work must only be carried out in well-ventilated rooms and while wearing an appropriate respiratory mask! We recommend: respiratory protection half mask DIN EN 141/143 protection level P3. For all maintenance work ensure a cautious handling of filter elements and components in order to avoid whirling up dust.



The operator is obliged to store and dispose of the collected dust in accordance with national or regional regulations. For all maintenance or cleaning work please refer to the applying environmental regulations. Pollutants and filter elements must be disposed of or stored according to the regulations as well. If you have any doubts, we recommend contacting a disposal contractor in your area.

## 7.1. Reset to maintenance state

- Switch off the unit. Then disconnect the unit from the power supply by setting the main switch in the “OFF” position. Secure the unit against unauthorized restarting during maintenance.



- Disconnect the compressed air hose of the external compressed air supply from the insert sleeve (see chapter 2.1). Empty the compressed air tank by opening the drain valve (see chapter 2.1) with a suitable screwdriver. Minor quantities of condensation water can leak out when opening the drain valve. Close the drain valve when the compressed air tank is entirely empty.

**CAUTION** When opening the drain valve a compressed air blast can occur!

- After completion of all maintenance work the unit can be reconnected to the power supply and the external compressed air supply.

## 7.2. Cleaning the filter cartridges

	<b>CAUTION</b>
<p><b>A sudden jet of compressed air and huge amounts of whirled up dust are possible due to an automatic cleaning with an opened service door.</b></p> <p>During the operation of the device, the service door of the filter housing must not be opened. The same applies to the ready to operate condition (standby) as there is also the possibility of an automatic cleaning (subsequent cleaning).</p>	

The filter cartridges are reusable filters and can be cleaned. The cleaning of the filter cartridges is automatically carried out.

The degree of pollution of the filter cartridges is electronically monitored. In order to assure the required extraction capacity of the device, the cleaning of the filter cartridges starts automatically when a preset differential pressure value is reached. If the preset differential pressure value is not undercut after the cleaning of the filter cartridges, another cleaning starts. The filter unit remains in operation during the automatic cleaning. The compressed air blast is produced in opposite direction to the intake. The cleaned dust falls downwards in the dust collecting tank.

Depending on the setting of the control unit there can be automatic postcleanings of the filter cartridges even when the unit is switched off.

When the maximal admissible differential pressure value is reached, the device triggers an alarm (see chapter “description of the control elements”). If despite of the automatic cleaning of the filter cartridge the alarm value is not undercut anymore, the filter cartridge must be replaced. (see chapter: “Replacing the filter cartridges”).

The differential pressure values in the control unit that initiate a cleaning or a filter alarm are preset values adapted to the filter unit. Please find detailed information concerning the functioning in the enclosed operating instructions of the control unit.

When using optional extraction elements with a suction hood, their throttle valve must be closed as soon as the device is switched off. Otherwise dust can escape from the suction hood in case of possible automatic subsequent cleanings.

### 7.3. Replacing the filter cartridges





Replacing the filter cartridges becomes necessary when the filter cartridges are saturated with dirt in a manner that despite of the cleaning the filter alarm is triggered again at very short intervals or permanently. (The filter alarm is described in chapter "Cleaning the filter cartridges".)



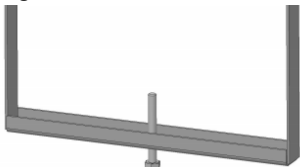
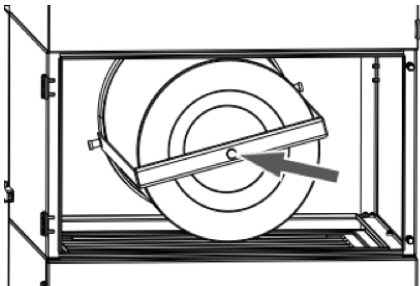

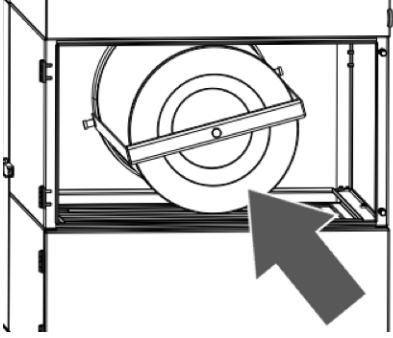
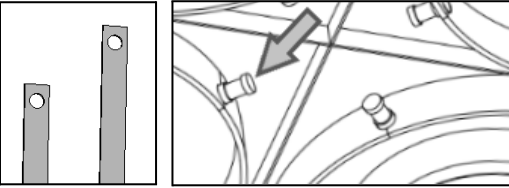

	<b>CAUTION</b>				
	<p><b>Whirling up dust is possible due to the polluted filter cartridges. Danger of unintentional automatic cleaning with the unit switched off.</b></p> <p>The filter cartridges must be cleaned before being replaced. This is done by carrying out 3 manual cleanings via the unit control (see separate operating instructions). The filter unit must be switched off beforehand but without disconnecting the unit from the power supply. After the cleaning, disconnect the filter unit from the power supply and secure it against being switched on again. After cleaning the filter cartridges wait about 5 minutes before opening the service door of the filter housing.</p>				
<table border="1"><tr><td style="text-align: center;"></td><td style="text-align: center;"></td><td style="text-align: center;"></td><td style="text-align: center;"></td></tr></table>					





	We recommend to coat new filter cartridges with cartridge protection before the first commissioning. Refer to the chapter "Coating of new filter cartridges with cartridge protection".
--	---

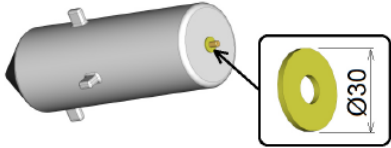

<ul style="list-style-type: none"> <li>• We recommend that two people work together to replace the filter cartridges.</li> <li>• We recommend spreading out a protective film in order to keep the area around the unit clean.</li> </ul>	
<ul style="list-style-type: none"> <li>• <b>CAUTION</b> The filter cartridges may only be replaced in well-ventilated rooms and while wearing an appropriate respiratory mask! We recommend: Respiratory protection half mask DIN EN 141/143 protection level P3.</li> <li>• We also recommend using additional protective clothing such as gloves, disposable overalls and protective eyewear.</li> </ul>	
<ul style="list-style-type: none"> <li>• Before replacing the filter cartridges, make sure you have a suitable container (e.g. PE bag) for disposal.</li> <li>• <b>CAUTION</b> The contaminated filter cartridges must be packed in a suitable container (e.g. PE bag). PE bags are available as an option (see spare parts list)! We recommend that you procure disposal bags at an early stage.</li> </ul>	
<ul style="list-style-type: none"> <li>• Open the filter housing's service door.</li> </ul>	<p>10 </p>
<ul style="list-style-type: none"> <li>• Loosen the fixing screw. This is located at the bottom of the cartridge holder. Loosen the fixing screw but do not unscrew it from the cartridge holder. It is important that the cartridge holder is still held loosely.</li> </ul> 	<p>17 </p> 

<ul style="list-style-type: none"><li>● Pull the disposal bag over the cartridge holder and filter cartridge.</li></ul>	
<ul style="list-style-type: none"><li>● Unhook the cartridge holder from the cartridge guides.</li></ul>  <ul style="list-style-type: none"><li>● Remove the cartridge holder with the filter cartridge and the disposal bag from the filter housing.</li></ul>	
<ul style="list-style-type: none"><li>● Briefly lift the filter cartridge in order to release it from the cartridge holder.</li><li>● Next, pull the cartridge holder with little dust on it out of the disposal bag and past the filter cartridge.</li></ul>	
<ul style="list-style-type: none"><li>● Insert the bag into the inside of the filter cartridge at the top.</li><li>● Then place the filter cartridge on its side.</li></ul>	

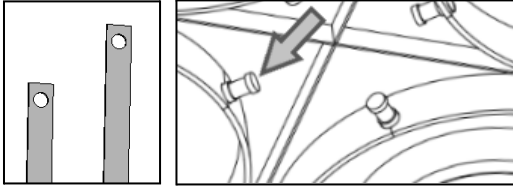
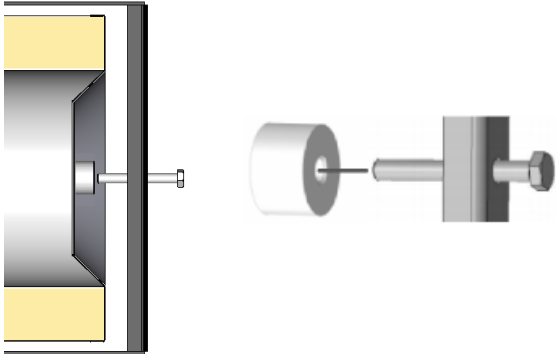
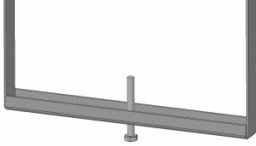
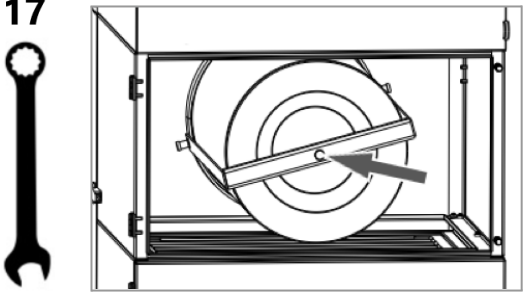
<ul style="list-style-type: none"> <li>• Undo the cylindrical nut. This is located at the base of the filter cartridge. When doing this, do not grip the cylindrical nut directly with your hands but from outside through the bag.</li> </ul>  <ul style="list-style-type: none"> <li>• Place the filter cartridge upright again. Remove the cylindrical nut from the bag.</li> </ul>	
<ul style="list-style-type: none"> <li>• Remove the displacer from the filter cartridge.</li> </ul> 	
<ul style="list-style-type: none"> <li>• Seal the disposal bag (e.g. with cable ties).</li> </ul> <div data-bbox="260 1245 772 1382" style="border: 1px solid black; padding: 5px;">  <p>The operator is obliged to store and dispose of contaminated filter cartridges in accordance with national or regional regulations.</p> </div>	
<ul style="list-style-type: none"> <li>• First of all, remove <u>all</u> the filter cartridges as described in the steps above.</li> </ul>	
<ul style="list-style-type: none"> <li>• Only then should you start to install the new filter cartridges.</li> </ul> <p><b>NOTICE</b> Only use TEKA replacement filters. Otherwise the correct functioning of the unit is not guaranteed.</p>	

<ul style="list-style-type: none"> <li>Insert the displacer into the new filter cartridge in such a way that the displacer's screw passes through the opening in the base of the filter cartridge.</li> </ul> <p><b>NOTICE</b> Check whether the seal is in contact at the thread of the displacer and that it is undamaged. Otherwise, it is necessary to use a replacement seal (see spare parts list).</p> 	
<ul style="list-style-type: none"> <li>Screw the displacer tight with the cylindrical nut.</li> </ul> <p><b>NOTICE</b> When you do this, the side of the large chamfer (A) of the cylindrical nut must face outwards.</p>	
<ul style="list-style-type: none"> <li>Insert the new filter cartridge in the cartridge holder. When you do this, the fixing screw must engage in the cylindrical nut.</li> <li>Insert the cartridge holder with the new filter cartridge in two of the cartridge guides.</li> </ul> 	
<ul style="list-style-type: none"> <li>Screw the fixing screw tight.</li> </ul> <p><b>NOTICE</b> If the fixing screw is not properly tightened then the seal at the top of the filter cartridge may not be pressed on sufficiently.</p> 	<p>17</p> 
<ul style="list-style-type: none"> <li>Close the service door.</li> </ul>	<p>10</p> 

## 7.4. Emptying the dust collecting tank

The dust collection container must be cleaned after a certain number of operating hours. This range depends on the amount of dust. The dust collecting tank may only be filled up to a maximum of 25%. The filling level has to be proofed at least once a week.

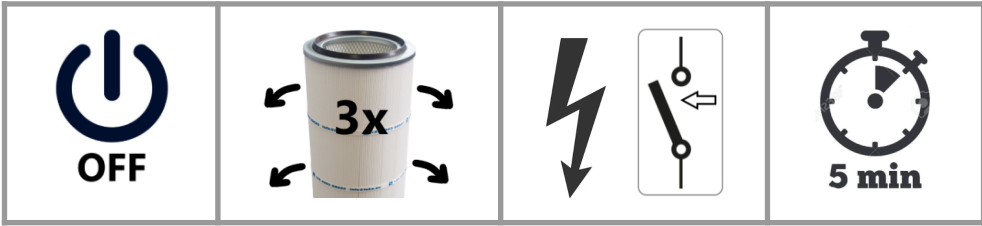
<b>CAUTION</b>
 <p><b>Whirling up dust is possible due to the polluted filter cartridges! Danger of unintentional automatic cleaning with the unit switched off.</b></p> <p>The filter cartridges must be cleaned before emptying the dust collecting tank. This is done by carrying out 3 manual cleanings via the unit control (see separate operating instructions). The filter unit must be switched off beforehand but without disconnecting the unit from the power supply. After the cleaning, disconnect the filter unit from the power supply and secure it against being switched on again. After cleaning the filter cartridges wait about 5 minutes before opening the service door.</p>

 Before emptying the dust collecting tank hold ready an appropriate container (e.g. PE bag). The bags are optionally available at TEKA, see list of spare parts. We recommend having PE bags in stock.

- Open the toggle levers of the dust collection container (see chapter 2.1).
  - **CAUTION** The container can fall down when opening. Hold the dust collection container when opening it.
  - **CAUTION** Risk of contusion when opening the toggle levers.
- Carefully put the unhinged dust collection container on the floor.
- Close the dust collection bag (e.g. with a cable fastener).
- Remove the dust collection bag and store or dispose of it according to the regulations.
- Place a new dust collection bag in the dust collection container so that the bag is put over the edge of the dust collection container.
- Lift the dust collection container back under the chute and close it by means of the toggle levers.

## 7.5. Draining the condensate

Operation with compressed air can result in condensation water being gradually deposited in the compressed air tank. The condensed water must be emptied regularly. The maintenance interval depends heavily on the quality of the compressed air and cannot, therefore, be determined in advance.

	<b>CAUTION</b>
<b>When opening the drain valve a blast of compressed air is possible.</b> Open the drain valve slowly.	

- Empty the compressed air tank by opening the drain valve (see chapter 2.1) with a suitable screwdriver. Let the escaping condensate flow into a suitable container.





- Close the drain valve.

## 7.6. Coating of new filter cartridges with cartridge protection

Before the first commissioning new filter cartridges can be coated with cartridge protection. The cartridge protection assists against a "caking" of extracted particles on the filter surface and thus prolongs the life of the new filter cartridge.

Unlike with other maintenance work, this step must be carried out with the system switched on and operating. This is necessary to allow the cartridge protection to disperse on the surface of the filter cartridges through suction.

	<b>CAUTION</b>	
	<p><b>On contact the cartridge protection can be hazardous to the respiratory tract and cause skin irritation or eye irritation.</b> Observe the listed manufacturer instructions provided:</p> <p><i>Handling:</i> Avoid the formation of dust!  <i>Storage:</i> Seal the container tightly before storage!  <i>Respiratory protect:</i> Dust mask without protection level!  <i>Hand protection:</i> Protective gloves in cloth, rubber or leather!  <i>Eye protection:</i> Safety glasses with side shields!  <i>Body protection:</i> Anti-static work shoes!</p>	

	<b>CAUTION</b>
	<p><b>During operation of the device an automatic cleaning can take place. This involves the risk of a sudden jet of high-pressure air and excessive dust formation at the point of entry of the cartridge protection.</b> At first make sure that there is no compressed air in the compressed air tank. Please refer to the chapter "Reset to factory settings". Before switching the device back on, disconnect the compressed air hose from the device.</p>

- Provide sufficient cartridge protection. We recommend using **10 grams** for each **square metre** of the **filter surface**. The cartridge protection is available at TEKA (see list of spare parts).
- Choose the capture point in the suction pipe that is the closest to the filter cartridges. E.g. an inspection flap can be used as a capture point.

**NOTICE** Electrical short-circuit due to LED lighting possible. If the extraction cowl of a suction arm is chosen as an extraction point then this extraction cowl may only be used if it is not equipped with LED lighting. Otherwise, the cartridge protection must not be extracted via the extraction cowl but, for example, via the hose of the suction arm by disconnecting this from the extraction cowl for this period.

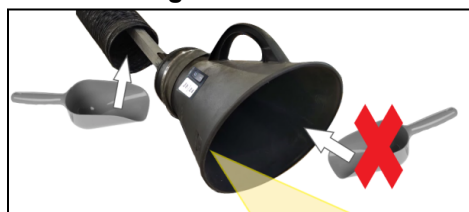

- Switch the device on.
- Let the cartridge protection bit by bit be sucked in via the capture point.

## 7.7. Cleaning the copper baffle plate

The copper baffle plate allows the air to circulate and therefore protects the filter cartridges.

The copper surface also helps break up and extinguish any sparks that may be sucked in. In order to maintain this function, it is necessary to clean the copper baffle as required. The maintenance interval is highly dependent on the application and cannot therefore be specified in advance.

	<b>CAUTION</b>
<p><b>Whirling up dust is possible due to the polluted filter cartridges.</b> The filter cartridges must be cleaned before the copper baffle plate is removed. This is done by carrying out 3 manual cleanings via the unit control (see separate operating instructions). The filter unit must be switched off beforehand but without disconnecting the unit from the power supply. After the cleaning, disconnect the filter unit from the power supply and secure it against being switched on again. After cleaning the filter cartridges wait about 5 minutes before opening the service door of the filter housing.</p>	

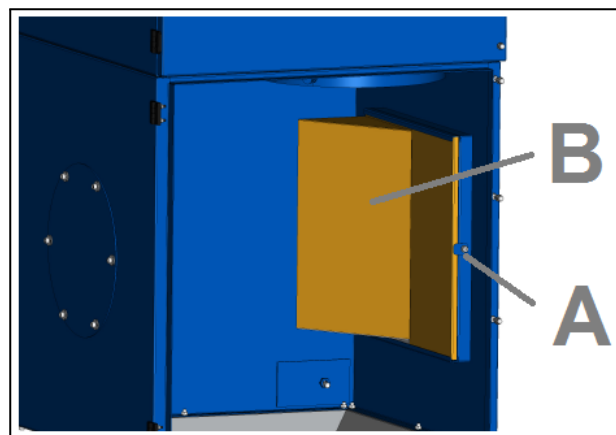



- Open the filter housing's maintenance door (see section 2.1).
- Release the fixing plate (A) of the insertable frame. Pull out the copper baffle plate (B).  
**NOTICE** If the copper baffle plate is located on the right then it is also necessary to remove the right-hand filter cartridge.
- Clean the copper baffle plate.
- Push the copper baffle plate back into the insertable frame. Screw the fixing plate back on firmly again.
- Close the maintenance door.



## 8. Dismantling / Disposal

Only authorised personnel may disassemble the machine.

	<b>WARNING</b>
	<p><b>Dangers arising from electricity.</b> Before the dismantling of the machine it has to be disconnected from the power supply and all supply lines.</p>

	<b>CAUTION</b>
	<p><b>Whirling up dust is possible due to the deposited dust.</b> During all work a suitable respiratory protection and protective clothing have to be worn.</p>

	The operator is obliged to store and dispose of the collected dust in accordance with national or regional regulations.
---	---

## 9. Diagnostics and troubleshooting

A list of possible system errors is provided in the table.

	<p>Error messages of the control unit are described in the enclosed operating manual of the control unit.</p> <hr/> <p>Faults indicated by control elements are explained in the chapter "Description of the control elements".</p>
---	---

A recommissioning of the device must only occur if it is ensured that the system is functionally equivalent to the original state. Repairs may only be carried out by TEKA personnel or, after consultation with TEKA GmbH, by the personnel authorised by the operator.

Adhere to the instructions in the chapter "Safety instructions" and "Maintenance" when carrying out any repairs. If in doubt, contact our TEKA service department:

Tel: +49 2541-84841-0

E-mail: [info@teka.eu](mailto:info@teka.eu)

Fault	Cause	Removal
System does not start.	Plug power supply is missing or incorrectly inserted.	Plug connector check power supply / plug in correctly.
	No power at outlet.	Check the mains, remove error if possible.
Dust at the dust collecting tank.	There is too much dust in the dust collection container.	Empty the dust collecting tank.
	The toggle closures are not closed.	Close the toggle closers.



	The seal of the dust collecting tank is damaged.	The seal must be replaced.
	The compressed air for the dedusting is set too high.	Reduce the compressed air.
Dust at the service door of the filter housing.	The door is not correctly closed.	Close the door.
	The seal between the service door and filter housing is damaged.	The seal must be replaced.
	The compressed air for the dedusting is set too high.	Reduce the compressed air.
	Escape of dust at the hinge.	The hinge must be reoriented or replaced.
Suction power too low (smoke hardly extracted).	Filter element is saturated.	Replace the filter package, dispose of old filter properly!
	Filter elements are saturated because no compressed air is connected.	Connect compressed air.
	Damage at the extraction elements.	Replace the extraction elements.
	The motor rotates in the wrong direction.	The rotating field of mains connection point must be changed.
	Suction line contracted.	Check and fix.
	Exhaust line contracted.	Check and fix.
	Maybe throttle valves are used in the suction line.	Adjust throttle valves.
The system is very noisy.	The motor rotates in the wrong direction.	The rotating field of mains connection point must be changed.
	There is no silencer mounted.	Mount the silencer.
	The suction line or exhaust line are not mounted.	Mount the line.
	The unit is untight.	Check and fix.

## 10. List of spare parts



Below, you will find a list of the various filter cartridges that can be installed in units of this type. We recommend that you order the filter cartridges that were supplied on initial delivery of the unit. Otherwise, the cleaning performance or lifetime of the filter cartridges may be impaired (due to differences in the filter material or filter surface area). If you have any doubts about which filter cartridges are needed for your unit type or your application, please contact our sales team and specify the machine number.

Filter element	Article no.
Filter cartridge, Type "BIA-M", 7,8m <sup>2</sup> (Ø327 x 600 mm) (CartMaster 1: 1 piece of these filter elements is required for the device) (CartMaster 2: 2 pieces of these filter elements are required for the device)	6160600107808
Filter cartridge, Type "BIA-M", 10,0m <sup>2</sup> (Ø327 x 600 mm) (CartMaster 1: 1 piece of these filter elements is required for the device) (CartMaster 2: 2 pieces of these filter elements are required for the device)	6160600110008
Filter cartridge, Type "easy clean plus" 12,5m <sup>2</sup> (Ø327 x 600 mm) (CartMaster 1: 1 piece of these filter elements is required for the device) (CartMaster 2: 2 pieces of these filter elements are required for the device)	6160600212508
Disposal elements	Article no.
PE-bag for the disposal of filter cartridges (4 pieces)	10030251702
PE-bag for inserting into the dust collecting tank (10 pieces)	10030251
Cartridge protection	Article no.
"NANNOX P50" for filter cartridges, 400g (in a bucket)	68130000400
"NANNOX P50" for filter cartridges, 100g (in a bucket)	68130000100
Other parts	Article no.
Seal for displacer (Ø30 mm / 1 piece)	9400000000

## 11. Technical data

Version		CartMaster wall 1 IFA	CartMaster wall 2 IFA
Supply voltage	V	400	
Frequency	Hz	50	
Type of current	Ph	3	
Engine power	kW	1,5	2,2
Air flow volume max.	m³/h	2500	3500
Negative pressure max.	Pa	2900	2900
Protection class		IP54	
ISO class		F	
Welding fume extraction class (according to EN ISO 21904-1 / -2)		W3	
Width	mm	665	665
Depth	mm	681	681
Height	mm	2113	2113
Weight	kg	ca. 210	ca. 220
Sound pressure level	dB(A)	72	
Allowed ambient temperature	°C	+5 to +35 (during operations) -10 to +40 (during transport and storage)	
Max. temperature of polluted air at the capture point	°C	+50	
Allowed max. humidity	%	70	
Compressed air supply		dry / oil-free	
Necessary external pressure	bar	see chapter "Connecting the compressed air supply"	

## 12. EC declaration of conformity

according to the Machinery Directive 2006/42/EG, Annex II, 1 A

TEKA Absaug- und Entsorgungstechnologie GmbH

Millenkamp 9, D-48653 Coesfeld

Tel.: +49 2541-84841-0

E-Mail: [info@teka.eu](mailto:info@teka.eu)

Internet: [www.teka.eu](http://www.teka.eu)

Designation of the device: CartMaster Wand 1 / 2 IFA

We hereby declare under our sole responsibility that the product mentioned above, from the serial number A22600010011001 resp. P57300010011001 on, conforms to the following directives:

<b>Machinery Directive:</b>	2006/42/EG
<b>Electromagnetic Compatibility:</b>	2014/30/EU
<b>Pressure equipment directive:</b>	2014/68/EU
<b>RoHS directive:</b>	2011/65/EU

This declaration will become void if the device is exposed to modifications that are not approved by the manufacturer in written form.

Authorized representative for the technical documentation:

TEKA Absaug- und Entsorgungstechnologie GmbH, Millenkamp 9, D-48653 Coesfeld

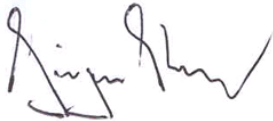

(Jürgen Kemper, managing director)

Coesfeld, 3rd January 2023



### 13. Training protocol

Designation of the device: CartMaster Wand 1 / 2 IFA

*(This form can be used by the operator to document the training of the employees. Training should be performed by authorized personnel only. Refer to the instructions in Chapter "Safety Instructions")*

By his signature, the employee confirms that he has been instructed regarding the following items:

Instruction	completed
Description of the device	
Operation and application of the device	
Explanation of the safety instructions	
Behavior in case of fire	
Explanation of the operation elements	
Change and dedusting of the filter elements	
Emptying of the dust collecting tank	
Appropriate disposal	
Maintenance works / Maintenance intervals	

Name of the employee (legible)	Signature

Introduction through (legible):	
Signature:	

## 14. Maintenance intervals

### 14.1. Usage-related maintenance

The described maintenances become necessary through the demands of the system operations. The maintenance intervals are recommendations. Depending on the application (multi-shift operation, dust generation, ...) it may make sense for the operator to change the intervals of maintenance, replacing and cleaning.

Maintenance work must always be documented by means of a protocol.

The approach of the maintenance measures is described in chapter "Maintenance".

Maintenance work	Chapter	Maintenance interval	
		recommended by TEKA	determined by the operator
Cleaning the filter cartridges	7.2	The cleaning of the filter cartridges is automatically carried out by the filter unit and thus is not subject to a maintenance interval.	
Replacing the filter cartridges	7.3	The saturation of the filter cartridges is automatically monitored by the filter unit and thus is not subject to a maintenance interval. The filter unit triggers an alarm when a replacement of the filter cartridges is necessary.	
Emptying the dust collecting tank (or check of fill level)	7.4	weekly	
Draining the condensate	7.5	monthly	
Cleaning the copper baffle plate (or check the degree of pollution)	7.7	semi-annually	

### 14.2. General maintenance

The described maintenances are independent from the demands of the system operations.

The operator is obliged to carry out repeated inspections and functional tests according to national regulations. If not otherwise covered by national regulations, the described maintenance intervals must be respected.

Maintenance work must always be documented by means of a protocol.

Maintenance work	Chapter	Maintenance interval
<b>Visual</b> inspection of the device	14.2.1	weekly
<b>Visual</b> inspection of the pipelines for dust deposits	14.2.2	monthly
<b>Visual</b> inspection of the pneumatic pipes	14.2.3	monthly
<b>Functional</b> test of the device	14.2.4	monthly
<b>Electrical</b> test of the electrical lines and earthing connections	14.2.5	annually

### 14.2.1. Visual inspection of the device

**Visual inspection:** Observation that there are no visible safety-related defects.

	<b>WARNING</b> <b>Danger arising from the ready to operate condition of the device.</b> Follow the procedure as described in the chapter "Set to maintenance state".
---	--

The following steps must be carried out in the course of the visual inspection:

- Check if all required pipeline elements, cable connections and hoses are connected to the filter unit
- Check all electrical earthing connections and cables for visible damages.
- Ensure that all parts are firmly connected.
- Check all connection points of the filter unit for escaping dust.
- Check all metal parts for corrosion or damages / changes of the coating.
- Check the inner filter area and the filter housing.
- Visual inspection of the control and operating elements as well as the outside running cables for damages.
- Check the dust collecting tank for tightness, check the sealing rubber of the tank.

### 14.2.2. Visual inspection of the pipelines for dust deposits

**Visual inspection:** Observation that there are no visible safety-related defects.

	<b>WARNING</b> <b>Danger arising from the ready to operate condition of the device.</b> Follow the procedure as described in the chapter "Set to maintenance state".
---	--

The following steps must be carried out in the course of the visual inspection:

- Open the inspection flaps of the pipeline and check the pipeline for dust deposits. Dust deposits must be eliminated.

### 14.2.3. Visual inspection of the pneumatic pipes

**Visual inspection:** Observation that there are no visible safety-related defects.

	<b>WARNING</b> <b>Danger arising from the ready to operate condition of the device.</b> Follow the procedure as described in the chapter "Set to maintenance state".
---	--

The following steps must be carried out in the course of the visual inspection:

- Open the service door of the cleaning housing .
- Carry out a visual inspection of the pneumatic parts.



#### 14.2.4. Functional test of the device

	<b>NOTICE</b>
<p><b>Possible material damage due to faulty condition of the unit.</b> Carry out a visual inspection before the functional test of the device as described in the previous chapters. The work as described in the chapter "Commissioning" must be finished.</p>	

The following steps must be carried out in the course of the functional test:

- Switch on the device.
- Pay attention to failures or error messages of the control unit. Also refer the separated operating manual of the control unit.
- Pay attention to extraneous noises or vibrations during the device's operation.
- Carry out a manual dedusting of the filter cartridges. Also refer to the separated operating manual of the control unit.
- Check if within one interval of the filter dedusting the number of dedusting shocks is equal to the number of filter cartridges (in each interval successively every filter cartridge becomes dedusted once).
- Check if dust is escaping from the unit during the dedusting cycle.
- A functional test should always be carried out with a connected / producing machine tool. Check if the collection of the fume or dust is sufficient. (Visual inspection).

#### 14.2.5. Electrical test of the electrical lines and earthing connections

	<b>WARNING</b>
<p><b>Danger arising from electricity.</b> The operator is responsible for ensuring that all work on electric components is carried out by authorised and qualified personnel.</p>	

The device is subject to regular electrical checks by the operator of the device, and are subject to national standards of the different countries.

The here recommended maintenance interval complies with the in Germany applying "Regulation 3 of the German Social Accident Insurance - Electrical plants and equipment" (formerly known as BGV-A3).

The check must only be carried out by a qualified electrician or a person trained in electrics using suitable measuring and test devices. The scope of testing and the methods must be in line with the respective national standard. All contacts in the control cabinet must be checked for tight fit, and must be readjusted if necessary.